



Model Number

SU19/110/115/123

Fiber optic sensor
with 2 m fixed cable

Features

- Classic line with display
- AGC (Automatic Gain Control) for faster teach-in
- Gang mounting for easy wiring
- Transparency recognition
- 30 µs High Speed Mode
- Master module

Product information

The fiber optics amplifier SU19 with display was developed to set a benchmark with the most comfortable and user-friendly interface. This simplicity of the settings decreases the costs of ownership significantly. The whole Teach-In process of objects is time-saving due to an easy Teach-In algorithm. The high resolution 4-digit percentage display indicates current values and thresholds with highest accuracy. Wire-saving and the replacement of devices is designed user-friendly and time-saving due to gang mounting on the rear.

Release date: 2018-01-15 17:08 Date of issue: 2018-01-15 805076_eng.xml

Dimensions

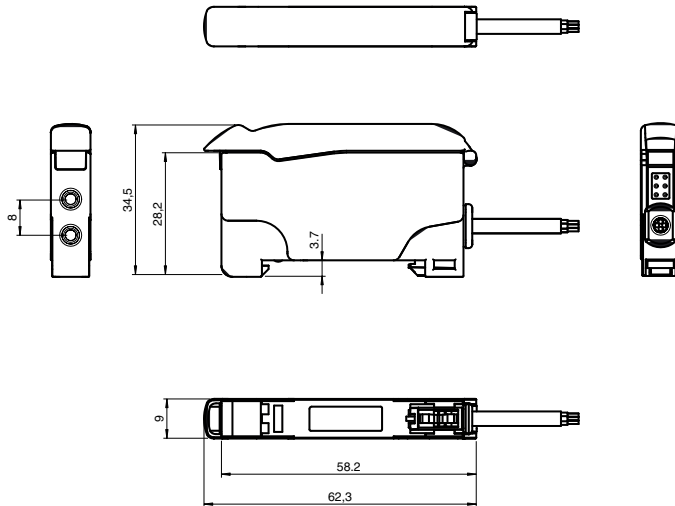

Electrical connection

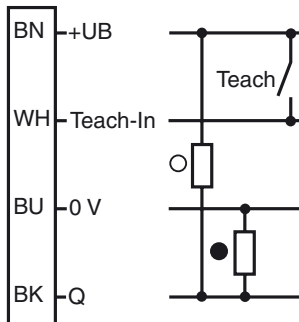

- = Light on
- = Dark on

Indicators/operating means

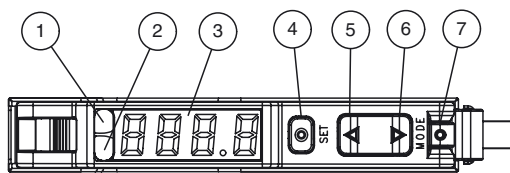

1	Operating display	green
2	Signal display	yellow
3	Display	
4	Button: Set	
5	Button: Up	
6	Button: Down	
7	Button: Mode	

Technical data**General specifications**

Sensor range	up to 150 mm (KLR-C02-2,2-2,0-K146)
Detection range	up to 450 mm (KLE-C01-2,2-2,0-K116)
Light source	LED
Light type	modulated visible red light , 660 nm
Ambient light limit	10000 Lux
Gang mounting	maximum 20 units

Functional safety related parameters

MTTF _d	500 a
Mission Time (T _M)	20 a
Diagnostic Coverage (DC)	0 %

Indicators/operating means

Operation indicator	Power on: static illumination , Undervoltage indicator: Green LED, pulsing (approx. 0.8 Hz) , short-circuit : LED green flashing (approx. 4 Hz)
Diagnostics indicator	7-segment display
Function indicator	LED yellow: static illumination switching state, flashes when falling short of the stability control
Control elements	Button (Mode) for menu choice ; Button (Set) for Teach-In ; Button (Up/Down) for fine adjusting and parameterization

Electrical specifications

Operating voltage	U _B	10 ... 30 V DC
Ripple		10 %
No-load supply current	I ₀	≤ 30 mA

Input

Function input	external Teach-In
----------------	-------------------

Output

Switching type	light/dark on selectable programmable	
Signal output	1 push-pull (4 in 1) output NPN/PNP , short-circuit protected	
Switching voltage	max. 30 V DC	
Switching current	max. 100 mA , resistive load	
Voltage drop	U _d	≤ 2 V DC at 100 mA ; ≤ 0.7 V at 10 mA
Switching frequency	f	High speed mode: 16 kHz , Standard mode: 3 kHz , High resolution: 250 Hz ~ 3 kHz (selection by the sensor), Automatic: 250 Hz , Glass mode: 250 Hz
Response time		High speed mode: 30 μs , Standard mode: 160 μs , High resolution: 2 ms , Automatic: 160 μs ~ 2 ms (choice by the sensor), Glass mode: 2 ms
Repeat accuracy	R	≤ 0.5 % of adjusted sensor range
Timer function		ON-delay, OFF-delay, one shot, pulse extension ; adjustable 0 ... 999 ms in 1 ms increments

Ambient conditions

Ambient temperature	-10 ... 55 °C (14 ... 131 °F)
Storage temperature	-20 ... 70 °C (-4 ... 158 °F)

Mechanical specifications

Housing width	9 mm
Housing height	34.5 mm
Housing depth	62.3 mm
Degree of protection	IP50
Connection	2 m PVC cable, 4 x 0,14 mm ²
Material	
Housing	PC
Mass	45 g

Compliance with standards and directives

Standard conformity	
Product standard	EN 60947-5-2:2007 IEC 60947-5-2:2007

Approvals and certificates

UL approval	cULus Listed, Class 2 Power Source, Type 1 enclosure
CCC approval	CCC approval / marking not required for products rated ≤36 V

Accessories**HPF-D032**

KLR-C02-2,2-2,0-K146
Plastic fiber optic - diffuse

KLR-C02-2,2-2,0-K70
Plastic fiber optic - diffuse

KLR-C02-1,0-2,0-K75
Plastic fiber optic - diffuse

KLR-C09-1,25-2,0-K76
Plastic fiber optic - diffuse

KLR-C09-1,25-2,0-K74
Plastic fiber optic - diffuse

KLR-C16-2,2-2,0-K71
Plastic fiber optic - diffuse

KHR-C02-2,2-2,0-K131
Plastic fiber optic - diffuse

KHTR-C02-2,2-2,0-K88
Plastic fiber optic - diffuse

LHR 00-0,8-1,0-20M4
Glass fiber optic - diffuse with silicon covering

KLE-C01-2,2-2,0-K116
Plastic fiber optic - thru-beam

KLE-C01-2,2-2,0-K103
Plastic fiber optic - thru-beam

KLE-C01-2,2-2,0-K102
Plastic fiber optic - thru-beam

KLE-C01-2,2-2,0-K100
Plastic fiber optic - thru-beam

KLE-C01-2,2-2,0-K101
Plastic fiber optic - thru-beam

KLE-C01-2,2-2,0-K113
Plastic fiber optic - thru-beam

KLE-C01-1,0-2,0-K120
Plastic fiber optic - thru-beam

KHE-C01-2,2-2,0-K122
Plastic fiber optic - thru-beam

KHTE-C01-2,2-2,0-K118
Plastic fiber optic - thru-beam

LHE 00-1,1-1,0-20M4
Glass fiber optic - thru-beam with silicon covering

Bracket SU
Mounting bracket for DIN rail

Other suitable accessories can be found at www.pepperl-fuchs.com

LED indicators and operating chart:

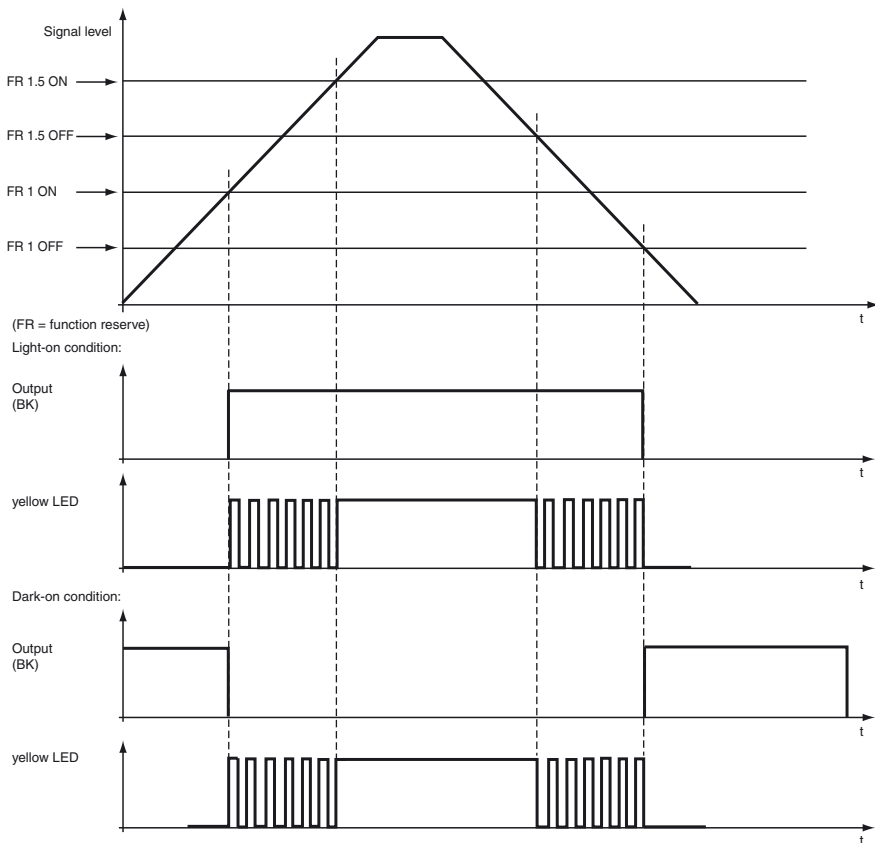

Teach-In methods

Maximum Teach-In

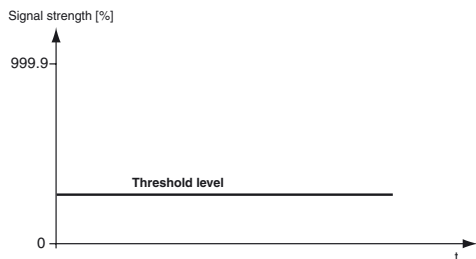

- Gain is set to maximum.
- Threshold is set to minimum.
- Maximum sensitivity is achieved.

Position Teach-In

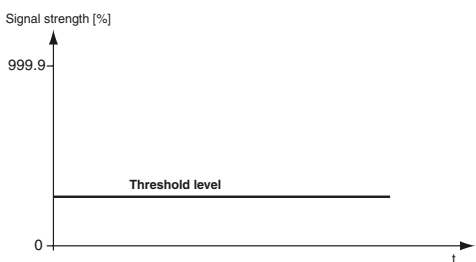

- Sensor set the optimum gain.
- Threshold is set to minimum.
- Signal received is ~ 100%.

2-Point Teach-In

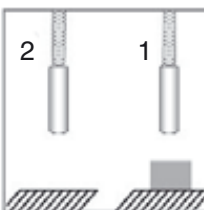
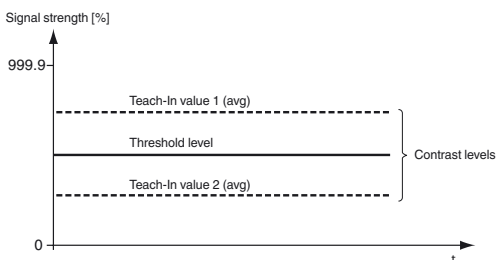

- Sensor set the optimum gain.
- Threshold is set in the middle of the 2 average taught values.

Release date: 2018-01-15 17:08 Date of issue: 2018-01-15 805076_eng.xml

Dynamic Teach-In

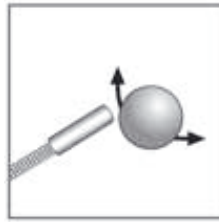
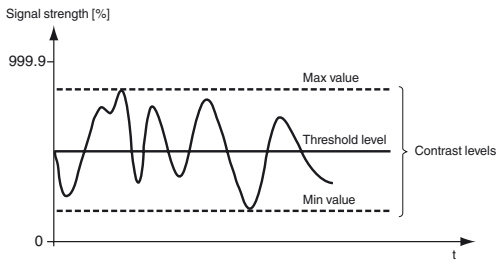

- Sensor set the optimum gain.
- Threshold is placed in the middle of the minimum and maximum taught values.

Glass detection Teach-In

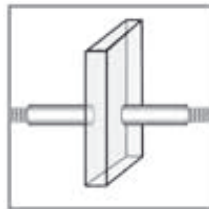
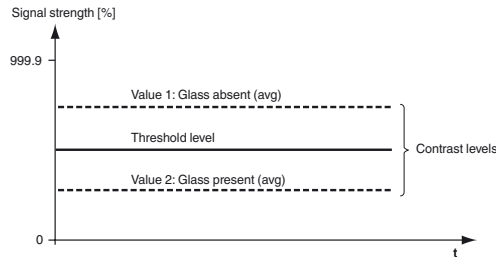

- Sensor set the optimum gain.
- Threshold is set in the middle of the 2 average taught values.

Modular construction

Selection of the maximum number of connectible slave modules to a master module for cross-talk suppression via bridge contacts.

Number of linkable units	Operating modes			
	Standard	High Resolution	Auto	Glass detection
6u	6 modules	6 modules	6 modules	6 modules
12u	12 modules	12 modules	12 modules	12 modules
18u	18 modules	18 modules	18 modules	18 modules

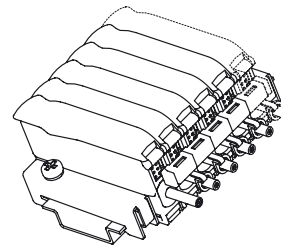

If 12u is selected, the switch-on delay doubles.
If 18u is selected, the switch-on delay triples.

When connecting several modules using bridge contacts, please ensure that the black blind pins on the bridge contacts are cut off. The outer blind pins must be retained only on the two outer bridge contacts. This is to seal off the pins that are not in use.

Master modules must **not** be connected to one another via the bridge contacts.

The power applied to the external input on the master module supplies the master module and all connected slave modules.

A master module is required to operate a slave module.

Information regarding current consumption:

- Maximum of 20 units (19 slaves per master). Maximum current consumption = 20 mA per unit.
- Maximum of 10 units (9 slaves per master). Maximum current consumption = 70 mA per unit.
- Maximum of 8 units (7 slaves per master). Maximum current consumption = 110 mA per unit.

Pay attention to the protective cover over the bridge contacts of the master modules

Menu structure

The menu structure has three levels:

Level 0: Press the "mode"-button. Select the required function via the "±" -button.
Press the "set"-button for confirmation.

Level 1: Select the required function via the "±" -button.
Press the "set"-button to confirm your selection.

Level 2: Use the "±" - button to select the required time delay in 1ms steps.
Press the "set"-button to confirm your selection.

To exit the menu, press the "mode"-button.

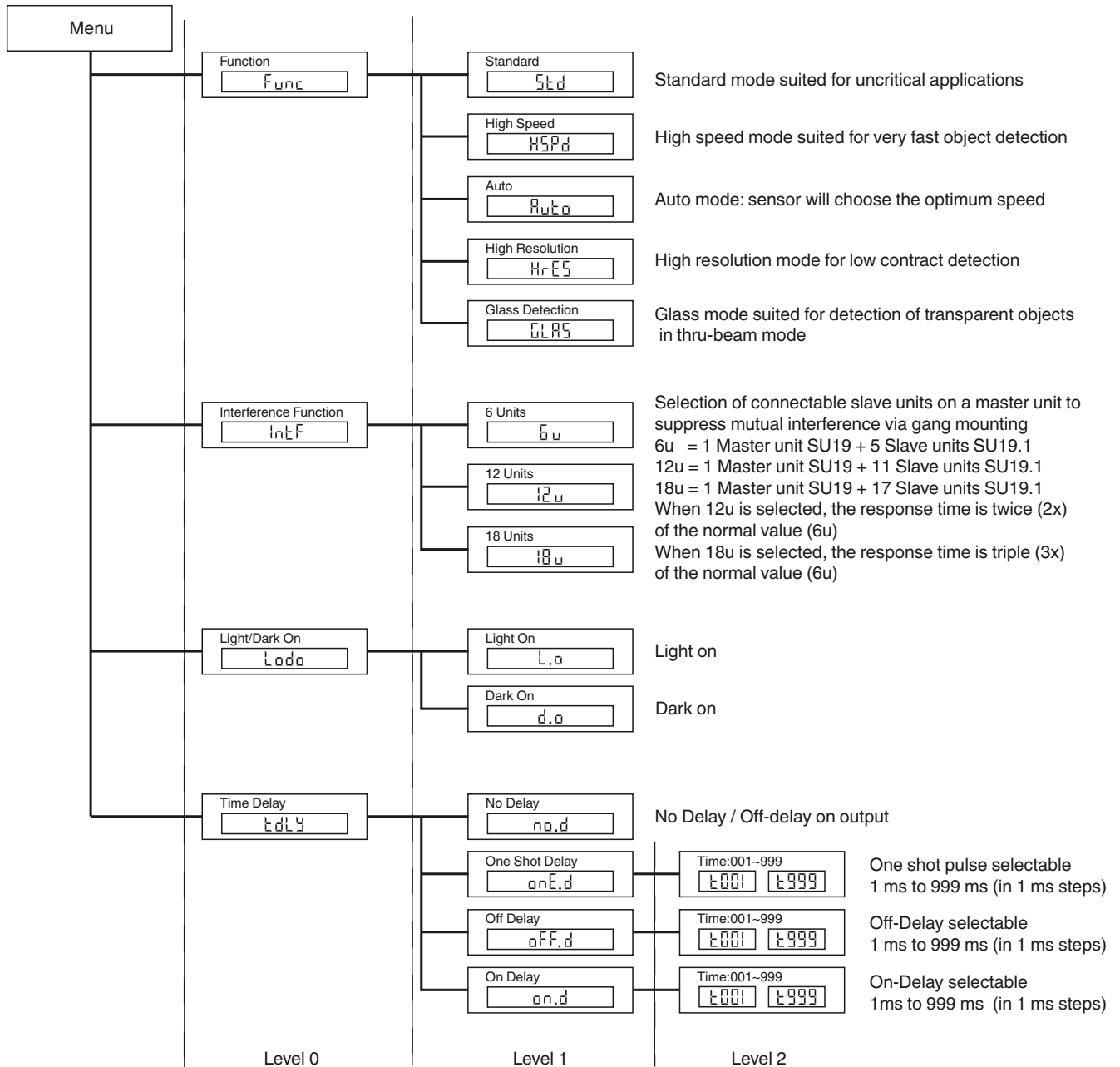

Release date: 2018-01-15 17:08 Date of issue: 2018-01-15 805076_eng.xml

Thru-Beam Optical Fiber Selection Table

Refer to "General Notes Relating to Pepperl+Fuchs Product Information".

Head type	Moun-ting	Designation	Core	Detection range	Fiber cross-section	Minimum object size	Length of fiber optics	Bending radius	Dimensional drawing	Special Properties
Cylindrical	Dia. 1.5 mm	KHE-C01-1.0-2.0-K139	PMMA	50 mm	0.5 mm	0.05 mm	2 m	At least 1 mm		Only 1 mm bending radius
Cylindrical	Dia. 3 mm	KHE-C01-2.2-2.0-K126	PMMA	50 mm	0.5 mm	0.15 mm	2 m	At least 1 mm		Only 1 mm bending radius
Cylindrical	Dia. 3 mm	KHE-C01-2.2-2.0-K123	PMMA	200 mm	1 mm	0.25 mm	2 m	At least 2 mm		Only 2 mm bending radius
Right angle	Dia. 15 x 5	KHE-C01-2.2-2.0-K137	PMMA	35 mm	0.5 mm	0.15 mm	2 m	At least 1 mm		Only 1 mm bending radius
Right angle	Dia. 15 x 5	KHE-C01-2.2-2.0-K140	PMMA	150 mm	1 mm	0.25 mm	2 m	At least 2 mm		Only 2 mm bending radius
Flexible										
Thread	M3 x 0.5 /M2.6	KLE-C01-1.3-2.0-K112	PMMA	200 mm	1 mm	0.25 mm	2 m	At least 25 mm		Four times higher detection range with auxiliary lens K-LA01/ Lateral optical face with K-LA02
Thread	M3 x 0.5	KLE-C01-2.2-2.0-K103	PMMA	220 mm	1 mm	0.25 mm	2 m	At least 25 mm		
Thread	M4 x 0.7 /M2.6	KLE-C01-2.2-2.0-K102	PMMA	220 mm	1 mm	0.25 mm	2 m	At least 25 mm		Four times higher detection range with auxiliary lens K-LA01/ eight times higher detection range with auxiliary lens K-LA06 Lateral optical face with K-LA02
Thread	M6	KLE-C01-2.2-2.0-K161	PMMA	330 mm	1 mm	0.32 mm	2 m	At least 25 mm		
Thread	M2.6	KLE-C01-2.2-2.0-K113	PMMA	200 mm	1 mm	0.25 mm	2 m	At least 25 mm		Four times higher detection range with auxiliary lens K-LA01/ Lateral optical face with K-LA02
Cylindrical	Dia. 2 mm	KLE-C01-1.3-2.0-K114	PMMA	220 mm	1 mm	0.25 mm	2 m	At least 25 mm		

Release date: 2018-01-15 17:08 Date of issue: 2018-01-15 805076_eng.xml

Refer to "General Notes Relating to Pepperl+Fuchs Product Information".

Pepperl+Fuchs Group
www.pepperl-fuchs.com

USA: +1 330 486 0001
fa-info@us.pepperl-fuchs.com

Germany: +49 621 776 4411
fa-info@de.pepperl-fuchs.com

Singapore: +65 6779 9091
fa-info@sg.pepperl-fuchs.com

Head type	Moun-ting	Designation	Core	Detection range	Fiber cross-section	Minimum object size	Length of fiber optics	Ben-ding radius	Dimensional drawing	Special Properties
Cubic	3 x M3 x 0.5	KLE-A16-2.2-2.0-K111	PMMA	100 mm	16 x 0.25 mm	0.05 mm	2 m	At least 25 mm		
Cubic	2 x 3.2 mm	KLE-A32-2.2-2.0-K142	PMMA	35 mm	32 x 0.25 mm		2 m	At least 25 mm		
Cubic	2 x 3.2 mm	LCE 00-1.6-0.5-K152	Glass	432 mm	0.15 x 14.7		520 m	At least 30 mm		
Resistant to high temperatures										
Cylindrical	Dia. 3 mm	KHTE-C01-2.2-2.0-K116	PMMA	115 mm	1 mm	0.35 mm	2 m	At least 25 mm		- 55 °C ... + 115 °C
Robust design										
Thread	M3	LHE 00-1.1-1.0-14M3	Glass	195 mm	1.1 mm		1 m	4 mm static		- 40 °C ... + 180 °C
Thread	M4 x 0.7 /M2.6	LHE 00-1.1-1.0-20M4	Glass	195 mm	1.1 mm		1 m	4 mm static		Four times higher detection range with auxiliary lens K-LA01/ eight times higher detection range with auxiliary lens K-LA06 Lateral optical face with K-LA02/ - 40 °C ... + 180 °C
Thread	M6	LHE 00-1.1-1.0-G	Glass	195 mm	1.1 mm		1 m	4 mm static		- 40 °C ... + 180 °C
Thread	M4 x 0.7/ M2.6	LME 00-1.0-1.0-K151	Glass	144 mm	1 mm		1 m	30 mm static		Temperature-resistant up to 350 °C (end segment, interval) Four times higher detection range with auxiliary lens K-LA01/ eight times higher detection range with auxiliary lens K-LA06 Lateral optical face with K-LA02
Cylindrical	Dia. 1.5 mm	LHE 00-1.1-1.0-10C1.5	Glass	195 mm	1.1 mm		1 m	4 mm static		- 40 °C ... + 180 °C
Cylindrical	Dia. 3 mm	LHE 00-1.1-1.0-15C3	Glass	195 mm	1.1 mm		1 m	4 mm static		- 40 °C ... + 180 °C
Right angle	M4 x 0.7/ M2.6	LME 00-1.2-1.0-K153	Glass	144 mm	1.2 mm		1 m	30 mm static		Temperature-resistant up to 350 °C (end segment, interval)

Release date: 2018-01-15 17:08 Date of issue: 2018-01-15 805076_eng.xml



Refer to "General Notes Relating to Pepperl+Fuchs Product Information".

Pepperl+Fuchs Group
www.pepperl-fuchs.com

USA: +1 330 486 0001
fa-info@us.pepperl-fuchs.com

Germany: +49 621 776 4411
fa-info@de.pepperl-fuchs.com

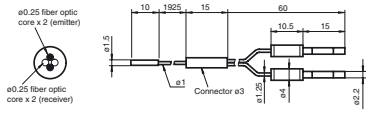
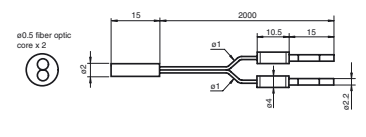
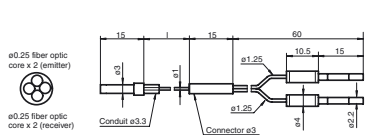
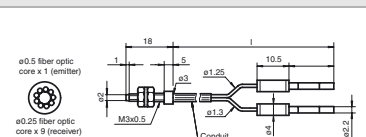
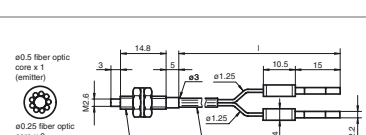
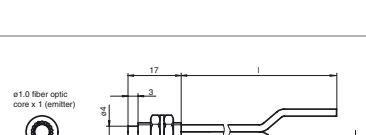
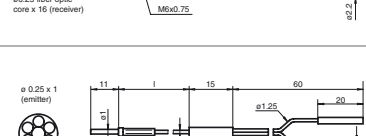
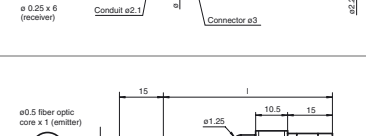
Singapore: +65 6779 9091
fa-info@sg.pepperl-fuchs.com

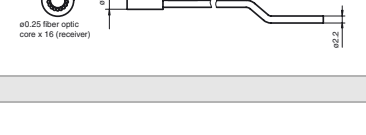
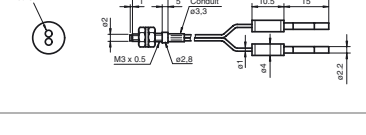
Head type	Mounting	Designation	Core	Sensing range	Fiber cross-section	Length of fiber optics	Bending radius	Dimensional drawing	Special Properties
Cylindrical	Dia. 1.5 mm	KLR-C04-1.0-2.0-K133	PMMA	7 mm	4 x 0.25 mm	2 m	At least 15 mm		
Cylindrical	Dia. 2.0 mm	KLR-C02-1.0-2.0-K87	PMMA	25 mm	2 x 0.5 mm	2 m	At least 15 mm		
Cylindrical	Dia. 3.0 mm	KLR-C04-1.25-2.0-K79	PMMA	8 mm	4 x 0.25 mm	2 m	At least 15 mm		
Coaxial									
Thread	M3 x 0.5	KLR-C09-1.25-2.0-K76	PMMA	30 mm	1 x 0.5 mm emitter 9 x 0.25 mm receiver	2 m	At least 15 mm		Only 0.5 mm light spot at 8 mm With auxiliary lens K-LA03
Thread	M4 x 0.7 /M2.6	KLR-C09-1.25-2.0-K74	PMMA	30 mm	1 x 0.5 mm emitter 9 x 0.25 mm receiver	2 m	At least 15 mm		Only 0.7 mm light spot at 10 mm with auxiliary lens K-LA04/ two times higher detection range with auxiliary lens K-LA01/ three times higher detection range with auxiliary lens K-LA06
Thread	M6 x 0.75	KLR-C16-2.2-2.0-K71	PMMA	85 mm	1 x 1.0 mm emitter 16 x 0.25 mm receiver	2 m	At least 25 mm		
Cylindrical	Dia. 1.0 mm	KLR-C06-1.25-2.0-K81	PMMA	20 mm	1 x 0.25 mm emitter 6 x 0.25 mm receiver	2 m	At least 15 mm		
Cylindrical	Dia. 3.0 mm	KLR-C09-1.25-2.0-K77	PMMA	30 mm	1 x 0.5 mm emitter 9 x 0.25 mm receiver	2 m	At least 15 mm		
Cylindrical	Dia. 5.0 mm	KLR-C16-2.2-2.0-K72	PMMA	85 mm	1 x 1.0 mm emitter 16 x 0.25 mm Receiver	2 m	At least 25 mm		
Highly flexible									
Thread	M3	KHR-C02-1.0-2.0-K96	PMMA	12 mm	2 x 0.5 mm	2 m	At least 1 mm		
Thread	M4	KHR-C02-1.0-2.0-K95	PMMA	12 mm	2 x 0.5 mm	2 m	At least 1 mm		

Release date: 2018-01-15 17:08 Date of issue: 2018-01-15 805076_eng.xml

Refer to "General Notes Relating to Pepperl+Fuchs Product Information".

Pepperl+Fuchs Group
www.pepperl-fuchs.com

USA: +1 330 486 0001
fa-info@us.pepperl-fuchs.com

Germany: +49 621 776 4411
fa-info@de.pepperl-fuchs.com

Singapore: +65 6779 9091
fa-info@sg.pepperl-fuchs.com

Head type	Mounting	Designation	Core	Sensing range	Fiber cross-section	Length of fiber optics	Bending radius	Dimensional drawing	Special Properties
Thread	M4	KHR-C02-1.3-2.0-K92	PMMA	60 mm	2 x 1.0 mm	2 m	At least 2 mm		
Thread	M6	KHR-C02-2.2-2.0-K94	PMMA	12 mm	2 x 0.5 mm	2 m	At least 1 mm		
Cylindrical	Dia. 3.0 mm	KHR-C02-1.3-2.0-K93	PMMA	60 mm	2 x 1.0 mm	2 m	At least 2 mm		
Flexible									
Thread	M6 x 0.75	KLR-C02-2.2-2.0-K70	PMMA	80 mm	2 x 1.0 mm	2 m	At least 25 mm		
Cylindrical	Dia. 3.0 mm	KLR-C02-1.3-2.0-K86	PMMA	80 mm	2 x 1.0 mm	2 m	At least 25 mm		
Cylindrical	Dia. 5.0 mm	KLR-C02-2.2-2.0-K85	PMMA	80 mm	2 x 1.0 mm	2 m	At least 25 mm		
Flexible tip									
Thread	M3 x 0.5	KLR 00-1.0-2.0-K58	PMMA	20 mm		2 m	At least 15 mm		
Thread	M6	KLR 00-2.2-2.0-K57	PMMA	60 mm		2 m	At least 15 mm		
Long detection range									
Thread		KLR-C02-2.2-2.0-K146	PMMA	150 mm		2 m	At least 40 mm		
Thread		KLR-C10-1.25-2.0-K144	PMMA	30 mm		2 m	At least 15 mm		
Lateral optical face									
Thread	M6	KHR-C02-2.2-2.0-K131	PMMA	60 mm	2 x 1.0 mm	2 m	At least 2 mm		Only 2 mm bending radius

Release date: 2018-01-15 17:08 Date of issue: 2018-01-15 805076_eng.xml

Head type	Mounting	Designation	Core	Sensing range	Fiber cross-section	Length of fiber optics	Bending radius	Dimensional drawing	Special Properties
Thread	Dia. 5.0 mm	KHR-C02-1.0-2.0-K132	PMMA	15 mm	2 x 0.5 mm	2 m	At least 1 mm		Only 1 mm bending radius
Array									
Cubic	3 x M2 x 0.5	KLR-A18-1.3-2.0-K82	PMMA	25 mm	18 x 0.25 mm	2 m	At least 25 mm		
Cubic	3 x M3 x 0.5	KLR-A32-2.2-2.0-K83	PMMA	35 mm	10.85 mm	2 m	At least 25 mm		
Cubic	2 x 3.2 mm	KLR-A32-2.2-2.0-K141	PMMA	35 mm	16 x 0.25 mm	2 m	At least 25 mm		
Resistant to high temperatures									
Thread	M6	KHTR-C02-2.2-2.0-K88	PMMA	80 mm	2 x 1.0 mm	2 m	At least 25 mm		-55 °C ... +115 °C
Cylindrical	Dia. 5.0 mm	KHTR-C02-2.2-2.0-K89	PMMA	80 mm	2 x 1.0 mm	2 m	At least 25 mm		-55 °C ... +115 °C
Robust design									
Thread	M3 x 0.5	LHR 00-0.8-1.0-14M3	Glass	40 mm	0.8 mm	1 m	4 mm static		-40 °C ... +180 °C
Thread	M4 x 0.7	LHR 00-0.8-1.0-20M4	Glass	40 mm	0.8 mm	1 m	4 mm static		-40 °C ... +180 °C
Thread	M6	LHR 00-1.1-1.0-G	Glass	70 mm	1.1 mm	1 m	4 mm static		-40 °C ... +180 °C
Cylindrical	Dia. 4.5 mm	LHR 00-1.1-1.0-K1	Glass	70 mm	1.1 mm	1 m	4 mm static		-40 °C ... +180 °C
Special design									
Cubic		KHR-C02-1.0-2.0-K129	PMMA	5 ~ 10 mm	2 x 0.5 mm	2 m	At least 1 mm		Crossed light beam for background suppression Only 1 mm bending radius

Release date: 2018-01-15 17:08 Date of issue: 2018-01-15 805076_eng.xml

Refer to "General Notes Relating to Pepperl+Fuchs Product Information".

Pepperl+Fuchs Group
www.pepperl-fuchs.com

USA: +1 330 486 0001
fa-info@us.pepperl-fuchs.com

Germany: +49 621 776 4411
fa-info@de.pepperl-fuchs.com

Singapore: +65 6779 9091
fa-info@sg.pepperl-fuchs.com

